

SPECIFICATIONS

Current Rating: 3A AC,DC
 Voltage Rating: 250V AC,DC
 Temperature Range: -25°C ~ +85°C
 Contact Resistance: 30mΩ Max
 Insulation Resistance: 1000MΩ Min
 Withstanding Voltage: 1000V AC/minute
 Material: PA66,UL94V-0
 Color: Natural(White)/Black

Ordering Information & Dimensions

Ordering code:

E2001H00-NP X-L1-XX-NK
 ① ② ③ ④ ⑤

- ① No. of Circuits
- ② X : Product color(A--Y)
A : Black type
None : White
- ③ L1 : Lock
- ④ HF : Halogen Free
- ⑤ NK : No Mark
Blank : Mark

Part No	A	B	C
15P	33.80	32.10	28.00
14P	31.80	30.10	26.00
13P	29.80	28.10	24.00
12P	27.80	26.10	22.00
11P	25.80	24.10	20.00
10P	23.80	22.10	18.00
9P	21.80	20.10	16.00
8P	19.80	18.10	14.00
7P	17.80	16.10	12.00
6P	15.80	14.10	10.00
5P	13.80	12.10	8.00
4P	11.80	10.10	6.00
3P	9.80	8.10	4.00
2P	7.80	6.10	2.00

				GENERAL TOLERANCE		UNIT: mm		DATE		TITLE:		
				.X±0.30	X°±1°	DRAWN: 张自豪		2020.06.25		2.00mm PITCH HOUSING		
				.XX±0.20	.X°±	CHECKED:				PROJECT		
				.XXX±0.10	.XX°±	APPROVED:				PART NO. E2001H00-NPX-L1-XX-XX		
LTR	NAME	DATE	VERSION RECORD							DRAWING NO. E2001H-L1		
1	2	3	4	5	6	7	8	9				

东莞市宏欣蓝电子有限公司

PROJECT PART NO. E2001H00-NPX-L1-XX-XX

VER. SCALE: N/A
 A0 SHEET: 1/1



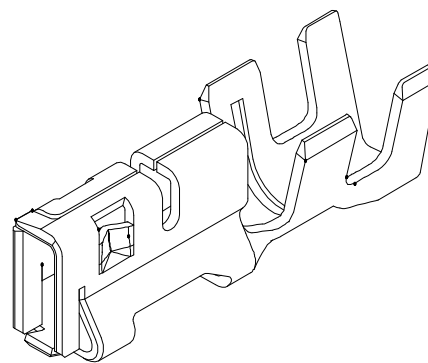
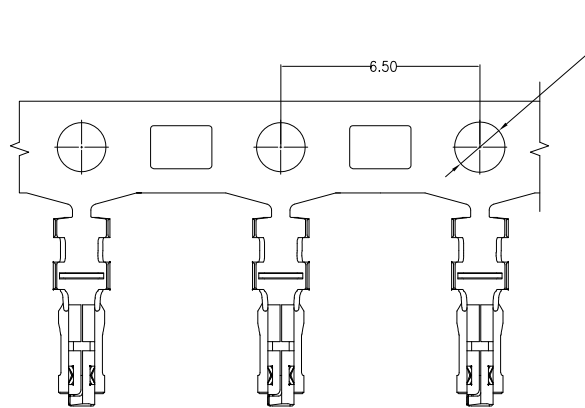

SPECIFICATIONS

Current Rating: 3A AC,DC
 Voltage Rating: 250V AC,DC
 Temperature Range: -25°C ~ +85°C
 Contact Resistance: 30mΩ Max
 Insulation Resistance: 1000MΩ Min
 Withstanding Voltage: 1000V AC/minute

Finish: 80-120u" TIN plated over
 30-50u" Nickel

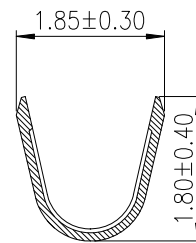
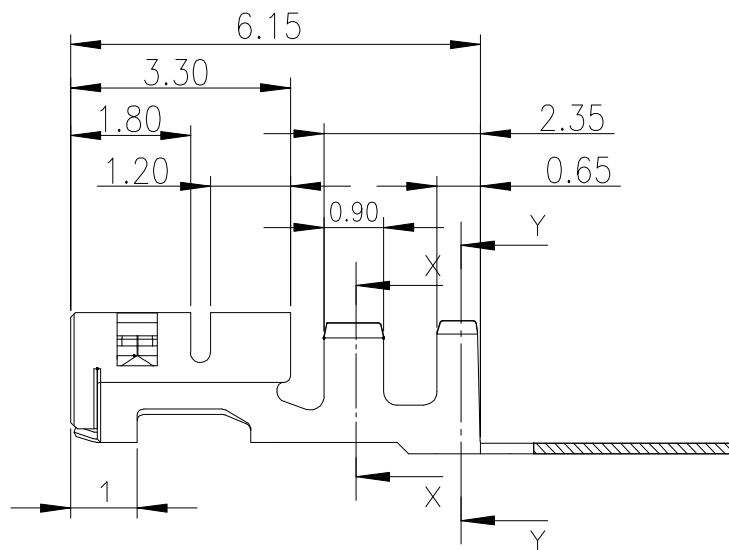

SECTION X-X

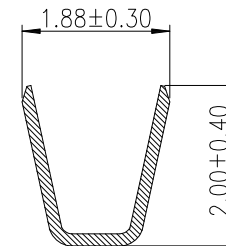

SECTION Y-Y

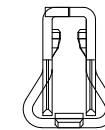
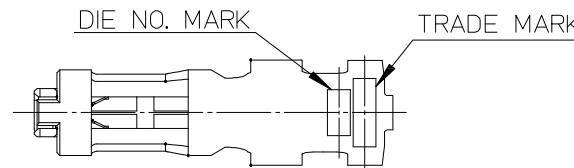
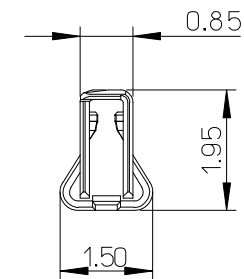

Ordering Information & Specifications

Part No	Wire Range	Insulation O.D.	Material	Finish	Qty/reel
E2001TOP-2E-L1-NK	AWG#24-30#	0.80mm(max)	Phosphor Bronze	Tin-plated	10,000pcs

GENERAL TOLERANCE				UNIT: mm		DATE		TITLE:		
.X±0.30	X° ±1°	DRAWN:	张自豪	2020.07.12		2.00mm PITCH CRIMP TERMINAL				
.XX±0.20	.X° ±	CHECKED:				VER.	SCALE:	N/A		
.XXX±0.10	.XX° ±	APPROVED:				A0	SHEET:	1/1		

东莞市宏欣蓝电子有限公司

PROJECT PART NO. E2001TOP-2E-L1-NK

DRAWING NO. E2001TOP-L1

LTR NAME DATE VERISION RECORD